



The airy design and the warm combination of teak and the soft woven straps, give the Mood collection an amazingly natural charm. The backs are handwoven with Tricord yarn that consists of polyolefin and polyester. The material is weather-resistant, but has nevertheless a very natural look and feel. The soft, rounded design of the table and chairs will create an intimate atmosphere on your patio.

MATERIALS

- Frame: plantation teak from East-Java, every part is handpicked during the cutting process of the tree
- Back: weaving with Tricord® on an aluminium frame. The backs can be replaced individually. Tricord consists of an indestructible polyester core and an outside covering of weather resistant polyolefin. It is the ultimate combination of the strength of polyester and the natural look and feel of polyolefin: strong on the inside, soft on the outside. Tricord is exclusively designed for Tribù and is UV- and rot resistant.

CUSHIONS

The cushions of the armchair, barchair and bench are made of dryfoam and therefore water-permeable. The cushions of the clubchair, lounge chair, sofa, lounge bed and daybed are water-repellent. The fillings of these cushions have a cover in a laminated, water-repellent polypropylene material which prevents water from penetrating. The thread used to stitch the seams swells when getting wet, preventing water from penetrating through the seams. Moreover, the seams are protected on the inside with an extra covering. If nevertheless water should penetrate, the material is breathable, letting moisture out to prevent moulding.

COLOURS STRAPS



MOOD

TECHNICAL DRAWINGS

06218-xx - Armchair

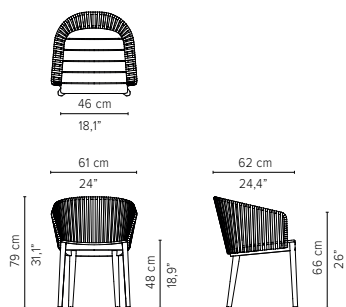

delivery unit: 1
 packaging: 63 x 63 x H55 cm - 0,22 m³
 11,5 kg
 cushions:
 C06218 (seat)
 C06218BW
 (lumbar cushion H24 cm)
 C0628BHW
 (high back cushion H38 cm)
 C0628BCA
 (casual back cushion H43 cm)

06216-xx - Barchair

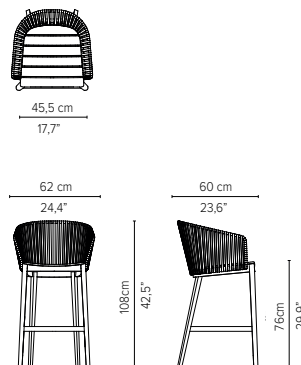

delivery unit: 1
 packaging: 62 x 62 x H85 cm - 0,32 m³
 14 kg
 cushions: C06218 (seat)
 C06218BW
 (lumbar cushion H24 cm)
 C0628BHW
 (high back cushion H38 cm)
 C0628BCA
 (casual back cushion H43 cm)

06202-xx - Lounge chair

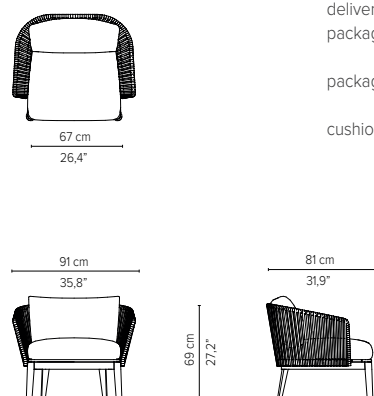

delivery unit: 1
 packaging A: 71 x 70 x H10 cm
 0,05 m³ - 10,7 kg
 packaging B: 92 x 56 x H73 cm
 0,37 m³ - 8,5 kg
 cushions: art. C06202W (seat)
 0,07 m³ - 2,7 kg
 C06202BW (regular back)
 0,03 m³ - 1 kg
 C06202BCA (casual back)

06208-xx - Sofa 2-seater

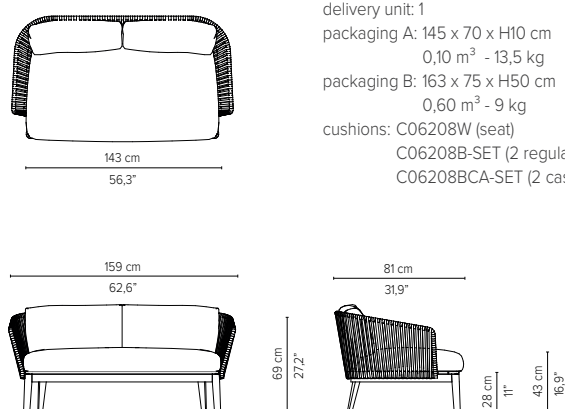

delivery unit: 1
 packaging A: 145 x 70 x H10 cm
 0,10 m³ - 13,5 kg
 packaging B: 163 x 75 x H50 cm
 0,60 m³ - 9 kg
 cushions: C06208W (seat)
 C06208B-SET (2 regular backs)
 C06208BCA-SET (2 casual backs)

06209-xx - Sofa 3-seater

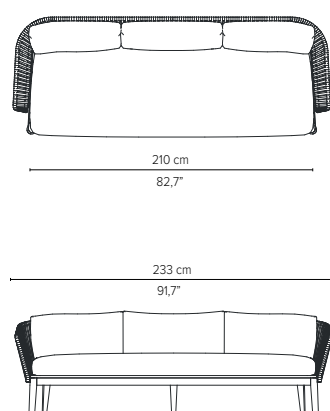

delivery unit: 1
 packaging A: 214 x 77 x H12 cm
 0,19 m³ - 30 kg
 packaging B: 236 x 81 x H54 cm
 1,03 m³ - 15 kg
 cushions: C06209W (seat)
 C06209B-SET (3 regular backs)
 C06209BCA-SET (3 casual backs)

* Appearances, measurements and weights may slightly differ from reality.
 The cushions on the drawings are not included in the article.

MOOD

TECHNICAL DRAWINGS

06249-xx Daybed

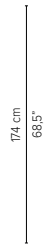
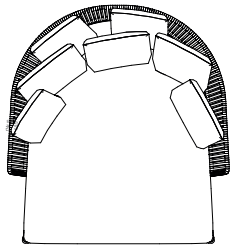

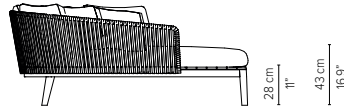
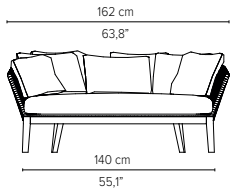

 delivery unit: 1
 packaging A: 168 x 143 x H10 cm
 0,24 m³ - 36 kg
 packaging B: 175 x 162 x H50 cm
 1,4 m³ - 16 kg
 cushions: C06249W (seat)*
 C06249B-SET (3 regular backs)
 C06249BCA-SET (3 casual backs)

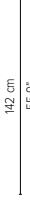
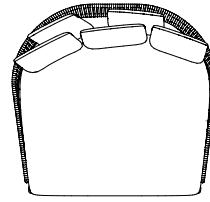

06250-xx Lounge bed



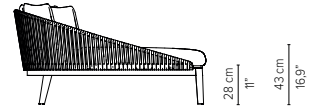
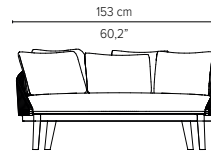

 delivery unit: 1
 packaging: 140 x 128 x H10 cm
 0,18 m³ - 28,75 kg
 packaging B: 173 x 155 x H50 cm
 1,03 m³ - 15 kg
 cushions: C06250W (seat)
 C06250B-SET (3 regular backs)



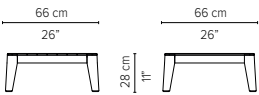

06282 - Coffee table 66 x 66 cm

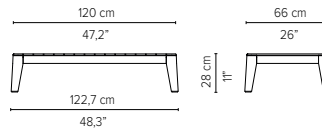
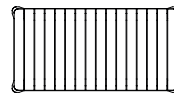

 delivery unit: 1
 packaging:
 70 x 70 x H13 cm - 0,06 m³
 13,7 kg
 cushion: C06282SW

06284 - Coffee table 120 x 66 cm



 delivery unit: 1
 packaging:
 125 x 70 x H13 cm - 0,11 m³
 20,3 kg

* Appearances, measurements and weights may slightly differ from reality.
The cushions on the drawings are not included in the article.

MOOD

PROTECTION COVERS

For each item a cover is available that protects the furniture against dirt. These covers in grey colour are made of PU coated polyester which is water-repellent and UV-resistant. Thanks to their excellent breathable qualities the covers reduce condensation and heat build-up, helping to prevent the formation of mold and mildew. Nevertheless, they are not 100% waterproof. Always make sure that furniture, cushions and covers are completely dry before covering furniture.

MAINTENANCE

Teak

Treat new teak with Teak Protector 4 to 6 weeks after installation. Teak Protector applies an invisible film that prevents stains and green deposit. Soiled teak can be cleaned with Teak Super Cleaner. Leave the furniture to dry completely and then apply Teak Protector. To avoid labour-intensive cleaning, you can treat the wood with Teak Sealer. A simple cleaning with water and a ph-neutral soap will do for many years. Teak Sealer contains UV protection to slow down the graying from the sun as well as a fungicide to prevent the growth of mold and mildew.



D9914
Teak Super
Cleaner



D9912
Teak Protector



D9959
Teak Sealer

Straps

Before use we recommend to treat the Tricord straps with Textile Protector which applies an invisible, dirt- and water repellent film. The weave can be cleaned with clear water and a pH-neutral detergent or Synthetics Super Cleaner. Allow the detergent to act for a while, then rinse abundantly with clean water. Drying may take a while on cloudy days.



D9922
Synthetics
Super Cleaner



D9924
Textile Protector

MOOD

TECHNICAL STANDARDS

06218 Armchair



ANSI/BIFMA X5.1-2011

EN1022:2005 6
EN581-1:2006 5
EN 1728:2012

ASTM B117-11 (MOD.)

CPSD-HL-01010-MTHD
CPSD-HL-01012-MTHD
CPSD-HL-01063-MTHD

AATCC 16
AATCC 106
AATCC 162

06202 Lounge chair



ANSI/BIFMA X5.1-2011

EN1022:2005 6
EN581-1:2006 5
EN 1728:2012

ASTM B117-11 (MOD.)

CPSD-HL-01010-MTHD
CPSD-HL-01012-MTHD
CPSD-HL-01063-MTHD

AATCC 16
AATCC 106
AATCC 162

06216 Barchair



ANSI/BIFMA X5.1-2011

EN1022:2005 6
EN581-1:2006 5
EN 1728:2012

ASTM B117-11 (MOD.)

CPSD-HL-01010-MTHD
CPSD-HL-01012-MTHD
CPSD-HL-01063-MTHD

AATCC 16
AATCC 106
AATCC 162

MOOD

PROJECT REFERENCES



Four Seasons, Kyoto, Japan – Mood lounge chair sofa & armchair



St-Regis Vommlu Resort, Maldives – Mood daybed, lounge chair & armchair



Four Seasons Megève, France – Mood lounge chairs

TRIBÙ